

# MAGNAVOX

AZ 8140 CD Radio Cassetterecorder

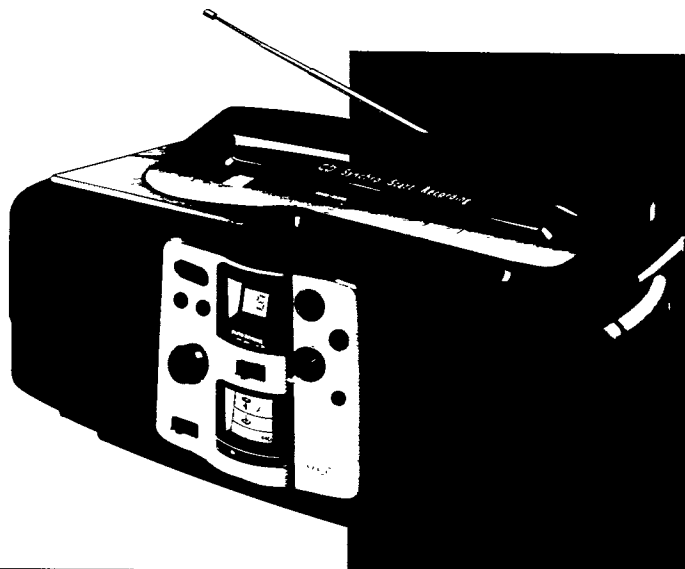

0 0 0 0 0 0 0 0 0 0 3 8 3 9



**(USA)**

## **English**

**page 5**

**English**

Safety Instructions  
Limited Warranty

page 4  
page 14

**(F)**

## **Français**

**page 17**

**Français**

Conseils De Sécurité  
Garantie Limitée

page 16  
page 27

**(E)**

## **Español**

**página 30**

**Español**

Instrucciones Sobre Seguridad  
Garantía Limitada

página 29  
página 40

**CLASS 1  
LASER PRODUCT**

Please follow these three important steps  
to get the most from your product

# MAGNAVOX

English

**1**

Return your owner's  
registration card within 10 days

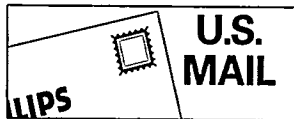

Registering your purchase is an essential step to guarantee that you'll receive all of the benefits you're entitled to as a Magnavox product owner.

Complete and mail your Owner's Registration Card today to ensure your right to warranty verification, owner confirmation, model registration, plus a wide variety of special services and savings.

**2**

Know these safety symbols



- ⚠ This bolt of lightning indicates uninsulated material within your unit may cause an electrical shock. For the safety of everyone in your household, please do not remove product covering.
- ⚠ This exclamation point calls attention to features for which you should read the enclosed literature closely to prevent operating and maintenance problems.

**3**

Read operating instructions  
carefully

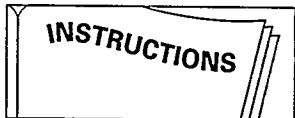

The information in this manual can help you take full advantage of your product's many features, and ensure years of safe, reliable operation. So don't miss out. Read the enclosed instructions, safety tips and warranty information today.

Congratulations on your new purchase ...  
and welcome to the Magnavox family!

Dear Magnavox family member:

Thank you for your confidence in Magnavox. You've selected one of the best-built, best-backed products available today.

We appreciate your support, and we'll do everything we can do to keep you happy with your purchase for many years to come. After all, you're the reason we're in business!

As a Magnavox family member, you're entitled to a world of special privileges - and our uncompromising commitment to your total satisfaction. Your Magnavox product is protected by one of the most comprehensive warranties and outstanding service networks in the industry.

What's more, your purchase qualifies you to receive advance information on exciting new products from Magnavox, convenient access to our home shopping network for special products and accessories, plus factory-direct rebates and discounts on your future Magnavox purchases.

All of this is our way of saying 'thanks' for joining the Magnavox family.

To start taking advantage of these great benefits, just remember to return your Magnavox Owner's Registration Card.

Simply complete, detach and mail us your Owner's Registration Card today. And enjoy your new purchase with our best wishes!

Sincerely,

Donald F. Johnstone  
President and Chief Executive Officer

**For Customer Use:**

Enter below the Serial No. which is located on the type plate on the base of the cabinet. Retain this information for future reference.

Model No. **AZ 8140**

Serial No. \_\_\_\_\_

## SAFETY

	<b>CAUTION</b> RISK OF ELECTRIC SHOCK DO NOT OPEN	
<b>CAUTION</b> TO REDUCE THE RISK OF ELECTRIC SHOCK, DO NOT REMOVE COVER (OR BACK). NO USER-SERVICEABLE PARTS INSIDE. REFER SERVICING TO QUALIFIED SERVICE PERSONNEL.		



This symbol warns the user that uninsulated voltage within the unit may have sufficient magnitude to cause electric shock. Therefore, it is dangerous to make any kind of contact with any inside part of this unit.



This symbol alerts the user that important literature concerning the operation and maintenance of this unit has been included. Therefore, it should be read carefully in order to avoid any problems.

## WARNING

To reduce the risk of fire or electric shock, do not expose this appliance to rain or moisture.

## CAUTION

Use of controls or adjustments or performance of procedures other than hereinafter may result in hazardous radiation exposure.

*The set complies with the FCC-Rules, Part 15 and with 21 CFR 1040.10.*

 Canada

This digital apparatus does not exceed the Class B limits for radio noise emissions from digital apparatus as set out in the Radio Interference Regulations of the Canadian Department of Communications.

## SAFETY INSTRUCTIONS – Read before operating equipment

This product was designed and manufactured to meet strict quality and safety standards. There are, however, some installation and operation precautions which you should be particularly aware of.

- Read Instructions** - All the safety and operating instructions should be read before the appliance is operated.
- Retain Instructions** - The safety and operating instructions should be retained for future reference.
- Heed Warnings** - All warnings on the appliance and in the operating instructions should be adhered to.
- Follow Instructions** - All operating and use instructions should be followed.
- Water and Moisture** - The appliance should not be used near water - for example, near a bathtub, washbowl, kitchen sink, laundry tub, in a wet basement or near a swimming pool, etc.
- Carts and Stands** - The appliance should be used only with a cart or stand that is recommended by the manufacturer.
-  An appliance and cart combination should be moved with care. Quick stops, excessive force, and uneven surfaces may cause the appliance and cart combination to overturn.
- Wall or Ceiling Mounting** - The appliance should be mounted to a wall or ceiling only as recommended by the manufacturer.
- Ventilation** - The appliance should be situated so that its location or position does not interfere with its proper ventilation. For example, the appliance should not be situated on a bed, sofa, rug, or similar surface that may block the ventilation openings; or, placed in a built-in installation, such as a bookcase or cabinet that may impede the flow of air through the ventilation openings.
- Heat** - The appliance should be situated away from heat sources such as radiators, heat registers, stoves, or other appliances (including amplifiers) that produce heat.
- Power Sources** - The appliance should be connected to a power supply only of the type described in the operating instructions or as marked on the appliance.

**11. Grounding or Polarization** -

The precautions that should be taken so that the grounding or polarization means of an appliance is not defeated

**Caution:** To prevent electric shock, match the wide blade of this plug to the wide slot, fully insert



- Power-Cord Protection** - Power supply cords should be routed so that they are not likely to be walked on or pinched by items placed upon or against them, paying particular attention to cords and plugs, convenience receptacles, and the point where they exit from the appliance.

- Cleaning** - The appliance should be cleaned only as recommended by the manufacturer.

- Power Lines** - An outdoor antenna should be located away from power lines.

- Nonuse Periods** - The power cord of the appliance should be unplugged from the outlet when left unused for a long period of time.

- Object and Liquid Entry** - Care should be taken so that objects do not fall and liquids are not spilled into the enclosure through openings.

- Damage Requiring Service** - The appliance should be serviced by qualified service personnel when:
  - The power supply cord or the plug has been damaged, or
  - Objects have fallen, or liquid has spilled into the appliance, or
  - The appliance has been exposed to rain, or
  - The appliance does not appear to operate normally or exhibits a marked change in performance, or
  - The appliance has been dropped, or the enclosure damaged.

- Servicing** - The user should not attempt to service the appliance beyond that described in the operating instructions. All other servicing should be referred to qualified service personnel.

# CONTROLS

English

Français

Español

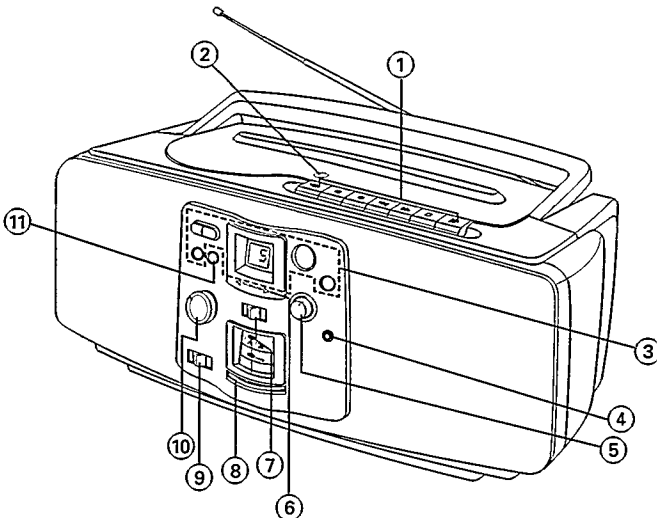

## TOP AND FRONT PANEL

- ① **CASSETTE DECK** keyboard (recording/playback) :
- ◀ ▶ **DIRECTION**
  - **RECORD**
  - **PLAY**
  - ◀◀ **REWIND** – fast rewind
  - ▶▶ **F. FWD** – fast forward wind
  - **STOP**
  - || **PAUSE**
- ② **OPEN-CLOSE** - to open and close the CD/Cassette door
- ③ **CD keyboard and display**
- ▶ **PLAY/PAUSE** button
  - **STOP** button
  - ◀◀ **PREVIOUS/NEXT** ▶▶ Press briefly to jump to a previous ◀◀ or next ▶▶ track during playback or **STOP** mode. During playback, keep backward◀◀ or forward▶▶ pressed down to search for the required passage. If you release the button, playback will continue.
  - SHUFFLE** button: play all tracks in a random order
- CD display, shows:**
- flashes indicating no CD inserted
  - TRACK** – the total number of tracks, and during play the number of the track being played
  - SHUFFLE** activated
  - PAUSE** activated
- ④ Ⓜ – stereo headphone socket
- ⑤ **TONE** control knob
- ⑥ ◀ ▶ **TAPE DIRECTION** indicator
- ⑦ **MODE** selector/**POWER** on/off switch
- ⑧ **TUNING** knob – to tune to radio stations.
- ⑨ **BAND** selector – for selecting FM or AM.
- ⑩ **VOLUME** control knob
- ⑪ **SPATIAL SOUND** button – for switching the spatial sound effect on and off for wider stereo effect.

## BACK PANEL

- ⑫ **MAINS** socket for mains lead

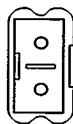

\* The type plate is located on the base of the set.

## SUPPLY

### Batteries

Whenever convenient, use AC mains supply if you want to conserve battery life.

- Open the battery compartment.

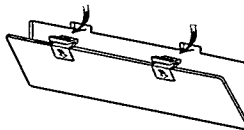

- Insert as indicated six (preferably Alkaline) batteries, type R20, UM1 or D-cells.

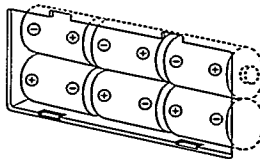

- The battery supply is switched off when the set is connected to the mains. When changing over to battery supply, remove the plug from the MAINS socket.
- Remove the batteries if exhausted or if they will not be used again for a long period.

### AC mains supply

- Check if the mains voltage as shown on the type plate (on the base of the set) corresponds to your local mains supply. If it does not, consult your dealer or service organisation.

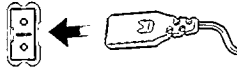

- Connect the mains lead to the MAINS socket ⑫ and the wall socket. The mains supply is now connected.
- To disconnect the set from the mains, withdraw the mains plug from the wall socket.

### CONNECTIONS

#### Stereo headphone socket ④ Ω

For stereo headphones with 3.5 mm plug. Inserting the plug will disconnect the loudspeakers.

### RADIO RECEPTION

- Set the MODE selector ⑦ to RADIO.

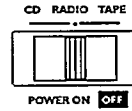

- Adjust the sound with the VOLUME ⑩ and the TONE ⑤ controls.

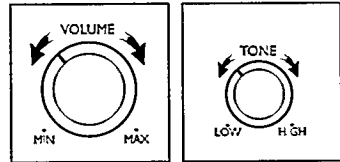

- Select the wave band using BAND selector ⑨.

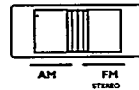

- Tune to the desired radio station by using the TUNING knob ⑧.

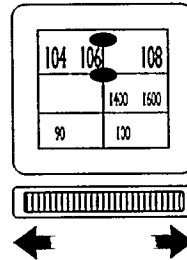

- For FM, pull out the telescopic aerial. To improve the FM-reception, incline and turn the aerial. Reduce its length if the FM signal is too strong (very close to a transmitter).
  - For AM, the set is provided with a built-in aerial, so the telescopic aerial is not needed. Direct the aerial by turning the whole set.
- The set is switched off if the MODE selector ⑦ is in the TAPE/POWER OFF position and with no cassette deck buttons pressed.

# COMPACT DISC

## PLAYING A DISC

- Set the MODE selector ⑦ to CD.



- Press OPEN-CLOSE ② to open the CD/Cassette door.

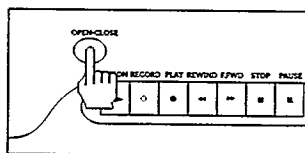

- Insert the CD, printed side facing up.
- Close the door. The CD-player starts and scans the contents list of the CD. After that, the number of tracks appear on the display and the CD-player stops.
  - If there are more than 39 tracks in the CD, "39" flashes.

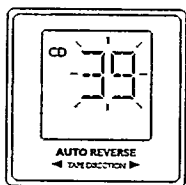

- Playback will start by pressing PLAY-PAUSE.

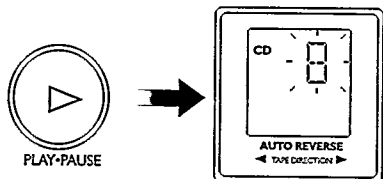

As soon as playback starts, the track number flashes in the display once.

- As playback continues, the display shows the current track number being played.

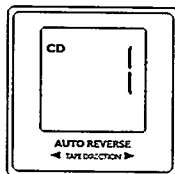

- Adjust the sound with the controls VOLUME ⑩ and the TONE ⑤.
- For a brief interruption, press PLAY-PAUSE.



PLAY-PAUSE

The word PAUSE then appears. To continue playback, press PLAY-PAUSE again.

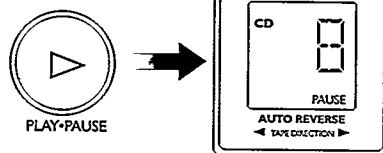

- To stop playback, press STOP ■.

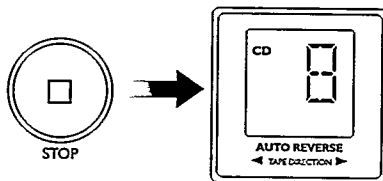

The CD player also goes to the STOP mode.

- by pressing OPEN-CLOSE ②;
- when the end of the CD is reached;
- if you move the MODE selector ⑦;
- if the batteries are exhausted or if the power supply is interrupted in another way.
- To take out the CD, open the CD/Cassette door by pressing OPEN-CLOSE ②. Open the CD/Cassette door only if the CD player or the Cassette player is in the STOP mode.
- The set is switched off if the MODE selector ⑦ is in the TAPE/POWER OFF position and with no cassette deck buttons pressed.

# COMPACT DISC

English

## Remarks

- If the battery voltage is not sufficient any more for playing a CD, the CD-player will not start.
- If E or a= appears after inserting a CD, the player cannot read the CD. Possible causes are:

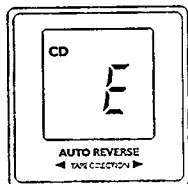

- you inserted the CD the wrong way: the label should be facing up or there is no disc;
- the CD is badly scratched or dirty, see 'Maintenance';
- the lens ⊗ is steamed up because of a sudden transition from a cold into a warm environment. Do not clean the lens, but let the set acclimatize for a while.

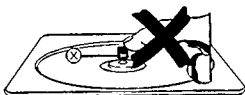

## Selecting a different track in the STOP mode

- You can select the desired title using ◀◀ PREVIOUS and NEXT ▶▶ until the display shows the required track number.

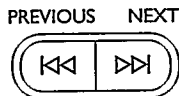

- Press PLAY•PAUSE to start playback.

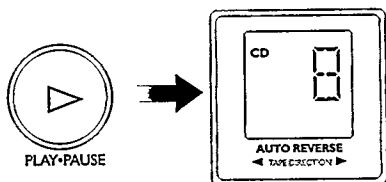

## Selecting a different track during play

- Press ◀◀ PREVIOUS or NEXT ▶▶ until the required track number appears in the display.

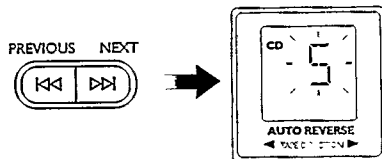

- Shortly after this, the chosen track will start playing.
- For the immediate previous track, press ◀◀ PREVIOUS twice.

## Starting again with the track that is currently playing

- Press ◀◀ PREVIOUS once.

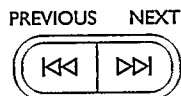

- The track will start playing from the beginning again.

## Searching for a passage during play

- Hold ◀◀ PREVIOUS or NEXT ▶▶ pressed down to search for the required passage. If you release the button, play will continue.

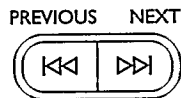

## Note:

This is an "AUDIBLE SEARCH". The volume will automatically be reduced to a low level during search operation and will resume its normal level when the search button is released.

## Shuffle Play

All the tracks of the disc can be randomly played.

- Press SHUFFLE once on the main unit before or during play.

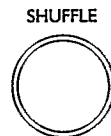



# COMPACT DISC

# CASSETTE

- The display shows **SHUFFLE** and playback starts with a track which has been randomly selected.

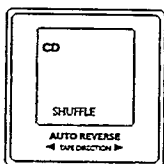

- During play you can use **NEXT** to select another random track, or **PREVIOUS** to play the same track again.

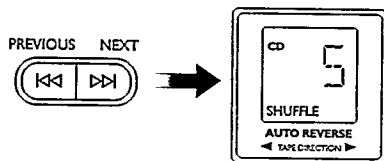

- Press **SHUFFLE** again if you wish to return to normal play.

## CASSETTE PLAYBACK

- Set the **MODE** selector to **TAPE**.

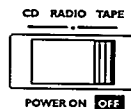

- Press **OPEN-CLOSE** to open the CD/Cassette door.
  - Ensure that the cassette deck buttons are released before you attempt to insert the cassette in.
  - Insert a recorded cassette and press it down lightly to ensure that it is positioned correctly.
- Press **OPEN-CLOSE** to close the CD/Cassette door.

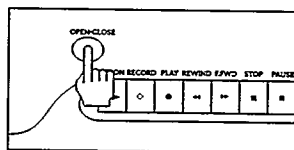

- Press **PLAY** and playback will start.
  - Playback changes direction automatically when the tape in the deck reaches the end.
  - The direction on the playback is indicated by the **LED** of the **TAPE DIRECTION**.
- Adjust the sound with the **VOLUME** and the **TONE** controls.

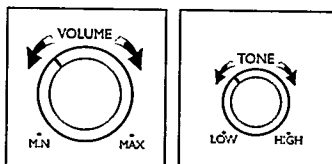

**Note:**

Playback: Chrome and Ferro Cassettes can be used.

- You can select the play direction by pressing the **DIRECTION** button. The tape direction indicators will show the playback direction of the tape deck.
- To interrupt playback, press **PAUSE**.

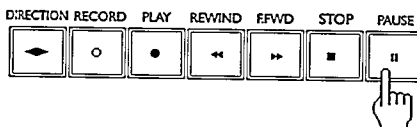

- To continue playback, press PAUSE II again.
- To stop playback, press STOP ■.

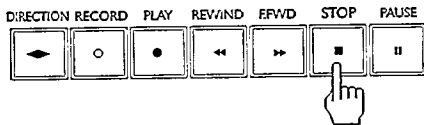

- The set is switched off if the MODE selector (7) is in the TAPE/POWER OFF position and with no cassette deck buttons pressed.

**Note:**

Before removing the cassette, ensure that all the cassette deck buttons are released.

**Winding the Cassette Tape**

- Press ►► to fast-forward the tape.

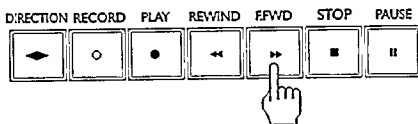

- Press ◀◀ to fast-rewind the tape.

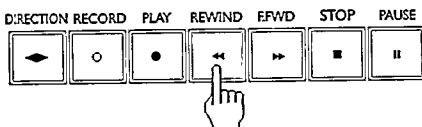

- Press STOP ■ to stop fast-forward or fast-rewind before the end of the tape.

**Note:**

During rewinding, press STOP ■ to stop fast-rewind at the end of the tape.

**RECORDING**

**GENERAL INFORMATION**

**Copyright:** Recording is permissible insofar as copyright or other rights of third parties are not infringed.

- The tape in the cassette is secured at both ends with leader tape. At the beginning and end of the cassette, nothing will be recorded for six to seven seconds.

Erasure prevention tabs



- For recording, use only ferro, IEC I/Type I Normal Position Cassette on which the tabs have not been broken.

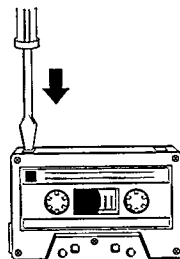

- The recording level is set automatically, regardless of the position of VOLUME (8).
- Accidental erasure can be prevented by breaking the small tab in the top left-hand corner of the back of the cassette. This protection can be reversed with a piece of adhesive tape placed over the same corner.

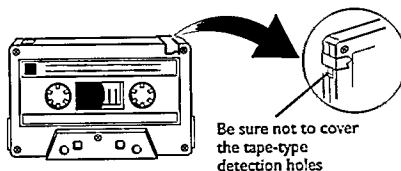

- Store the cassettes at room temperature and do not put them too close to magnets and transformers, for example, TVs and loudspeaker boxes.

# RECORDING

## Preparation

- Press OPEN•CLOSE ② to open the CD/Cassette door.

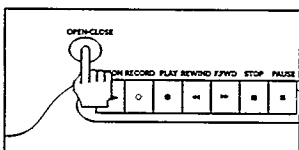

- Ensure that the cassette deck buttons are released before you attempt to insert the cassette in.
- Insert a blank cassette and press it down lightly to ensure that it is positioned correctly.
- Press OPEN•CLOSE ② to close the CD/Cassette door.
- When monitoring during recording, adjust the sound with the VOLUME ⑩ and the TONE ⑤ controls. These controls do not affect the recording.

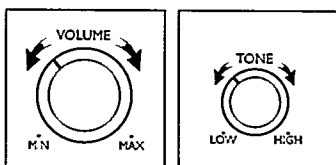

- if you want to record the other side of the cassette, flip the cassette in the deck over to continue recording.

## Recording from the CD-player

- Set the MODE selector ⑦ to CD. It's not necessary to start the CD-player separately; if you press RECORD ①, the CD-player starts automatically;

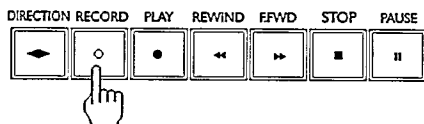

- if the CD-player is in the STOP mode, recording will start from the beginning of the disc;
- if the CD-player is in the PLAY mode/or at a certain track location (using << PREVIOUS/NEXT >>), recording will start from the beginning of that track;

## Note:

To activate the recording in the middle of a track, press RECORD ① to start recording; just as the CD begins to play, press PAUSE ② to stop recording. When the passage you want to record is reached, press PAUSE ② again to continue recording.

## Recording from the radio

- Set the MODE selector ⑦ to RADIO.

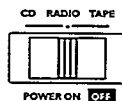

- Tune to the desired radio station described under RADIO RECEPTION.

## Starting and stopping the recording

- Start recording by pressing RECORD ①, in doing so, PLAY ② is pressed too.

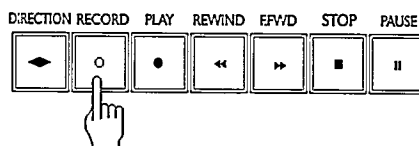

- For a brief interruption, press PAUSE ②. To continue recording, press PAUSE ② again.

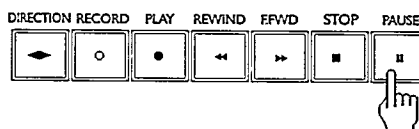

- To stop recording, press STOP ③.
- The set is switched off if the MODE selector ⑦ is in the TAPE/POWER OFF position and with no cassette deck buttons pressed.

# MAINTENANCE

English

## MAINTENANCE

### CD-player and CDs

- The lens (X) should never be touched or cleaned.

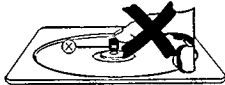

- The lens may steam up when the set is taken from a cold into a warm environment. Playing a CD is not possible then. Do not clean the lens, but let the set acclimatize for a while.
- Always pick up the CD by the edge and put it back in its box immediately after use.

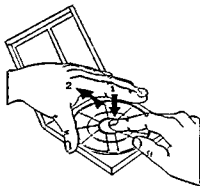

- To clean, breathe on the CD and wipe it off in a straight line from centre to edge using a soft, lint-free cloth. Cleaning agents may harm the CD.

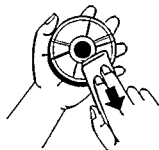

### Cassette deck

To ensure good recording and playback quality, clean the parts (A)(B)(C)(D) indicated after every 50 hours of operation or, on average, once a month.

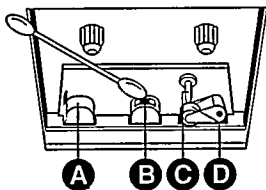

- Open the CD/cassette door by pressing OPEN-CLOSE (2).
- Use a cotton bud slightly moistened with alcohol or a special head cleaning fluid.
- Then press PLAY (3) and clean the rubber pressure roller (4).

- Press PAUSE (1) and clean the magnetic heads (A)(B) and the capstan (C).

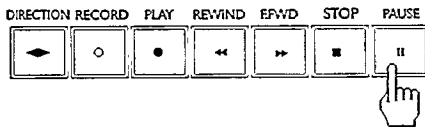

- After cleaning, press STOP (5).  
Cleaning of the magnetic heads (A)(B) can also be done by playing a cleaning cassette through once as an ordinary cassette.

### Remarks

- The CD-player and the cassette decks are fitted with self-lubricating bearings which must not be oiled or greased.
- Fingerprints, dust and dirt on the apparatus can be removed using a soft, clean and slightly damp leather cloth. Do not use any cleaning agents, since they may damage the cabinet.



- Keep the set, batteries, CDs and cassettes away from rain, moisture, sand and excessive heat, e.g. near heating equipment or in cars parked in the sun.



**Caution:** Invisible laser radiation when open and interlocks defeated. Avoid exposure to beam.

# TROUBLESHOOTING GUIDE

The following checks will assist in the correction of most problems which you may encounter with your portable set. Before going through the check list below, first check the following points.

☛ **The power cord must be connected firmly.**

Should any problem persist after you have made these checks, consult your nearest friendly dealer.

Radio Reception	
Symptom	Possible Causes (and Remedies)
Interference noise during FM stereo reception	Adjust the antenna. The signal strength is too weak.
Cassette Deck Operation	
Recording is not possible	No cassette in the cassette holder. The small tab has been broken (This can be reversed with a piece of adhesive tape) The tape is completely wound.
Not possible to remove the cassette from the deck/ Not possible to insert a cassette.	Check that all the cassette deck buttons are released. If not, press STOP ■.
Recording or playback cannot be made or there is a decrease in sound level	Dirty tape head Magnetic build-up in the record/playback head – See section on Maintenance on cleaning of tape heads.
Excessive wow or flutter, or sound drop-out.	Contamination of the capstans or pinch rollers.
CD Player Operation	
The PLAY ► does not function when pressed	The disc is not inserted correctly. The player is in PAUSE mode. Moisture condensation on the lens.
Track in the CD skips " E " is displayed	Dirty disc or scratched disc The disc is inserted upside down. The CD is dirty, badly scratched or warped. Try another disc Press PLAY•PAUSE again.
General	
Set not working	Hang up problem due to ESD and/or software Switch POWER ON/OFF or in the worst case, pull the mains plug out of the wall socket
Unit not working	Check that the power cord is connected firmly. Batteries not inserted correctly. Batteries exhausted, change the batteries. Remove the mains cord from the socket of the set if using batteries.
No sound output	Turn VOLUME clockwise. The headphones are connected, disconnect them. Change the batteries.
Lack of treble sound or apparently imprecise physical location of musical instruments	Check the TONE button.
Severe hum or noise	The TV or VTR is too close to the stereo system. Separate the portable set from the TV or VTR.

## LIMITED WARRANTY

### Magnavox Portable Compact Disc - One Year Carry-In Exchange -

#### One Year Coverage

For one year from the date of purchase, your Portable Compact Disc will be replaced with a new, renewed or comparable product (whichever is deemed necessary) if it becomes defective or inoperative. This is done without charge to you. Replacement products are warranted for the balance of the warranty period.

#### Who is Protected? ... Where?

This warranty is extended to the original retail purchaser for products purchased and used in the U.S.A., Puerto Rico, the Virgin Islands and Canada.

#### What the Purchaser Must Do

Before you call for service, check your operating instruction booklet. A slight adjustment of the customer control's discussed in your instruction booklet may save you a service call. This warranty does not cover commercial use, rental agreements, shipping damage, misuse or failure due to lack of normal care.

#### For product purchased in the U.S.A., Puerto Rico or the Virgin Islands

If you require service during the warranty period, you must take your portable product to the dealer from whom it was purchased, or carefully pack the product and ship it by prepaid transportation with proof of the purchase date to the Small Product Service Center\*, address listed below.

*In the U.S.A., Puerto Rico or the Virgin Islands, all implied warranties including implied warranties of merchantability and fitness for a particular purpose, are limited in duration to the duration of this express warranty. Some states do not allow limitations on how long an implied warranty lasts, so the above limitation may not apply to you.*

*This warranty gives you specific legal rights, and you may have other rights which vary from state to state.*

#### For product purchased in Canada

Replacement product can be arranged through your dealer who will advise of the nearest repair centre. To obtain warranty service, the product must be delivered (carried-in) to a Philips Consumer Service Centre (listed below), Philips Self-Servicing Dealer or Authorized Service Depot.

All that's required to validate your original factory warranty for products you purchase is to present your bill of sale as proof of purchase.

*In Canada, this warranty applies only to the normal service area of a Philips Consumer Service Centre, Philips Self-Servicing Dealer or Authorized Service Depot. Beyond this area, travel time or expense is the owner's responsibility.*

### How To Get Service On Your Portable Product After The One Year Warranty Expires

Out-of-warranty service can be obtained at a nominal cost for replacement and handling under the following arrangements:

#### For product purchased in the U.S.A., Puerto Rico or the Virgin Islands

1. Contact the Philips Service Company office (☎ 615/475-8869) to obtain the cost of out-of-warranty repair for your product. Please know your model number before you call.
2. Pack your product securely in a suitable container for shipment.
3. Mail the product to:

**\*Small Product Service Center  
Philips Service Company  
907 Snapps Ferry Road, Plant 2, Building 6  
Greeneville, Tennessee TN 37743  
☎ (615) 636 - 5740**

#### For product purchased in Canada

1. Call the nearest Canadian Philips Consumer Service Centre (listed below) to obtain the cost of out-of-warranty repair for your product. Please know your model number before you call.
2. Pack your product securely in a suitable container for shipment.
3. Mail the product to the nearest Canadian Philips Service Centre (listed below).

### Canadian Philips Consumer Service Centres

**Toronto**  
601 Milner Avenue  
Scarborough, Ontario  
M1B 1M8  
☎ (416) 754-6064 or 292-5161  
Fax ☎ (416) 754-6290

**Montréal**  
5930 Côte de Liesse  
Montréal, Québec  
H4T 1E1  
☎ (514) 342-9180  
Fax ☎ (514) 342-9372

**Vancouver**  
3695 Grandview Highway  
Vancouver, B.C.  
V5M 2G7  
☎ (604) 435-4411  
Fax ☎ (604) 435-9911

When your product is received, it will be replaced by a renewed (or comparable) product which meets Philips' high quality standards and shipped back to you by prepaid transportation.







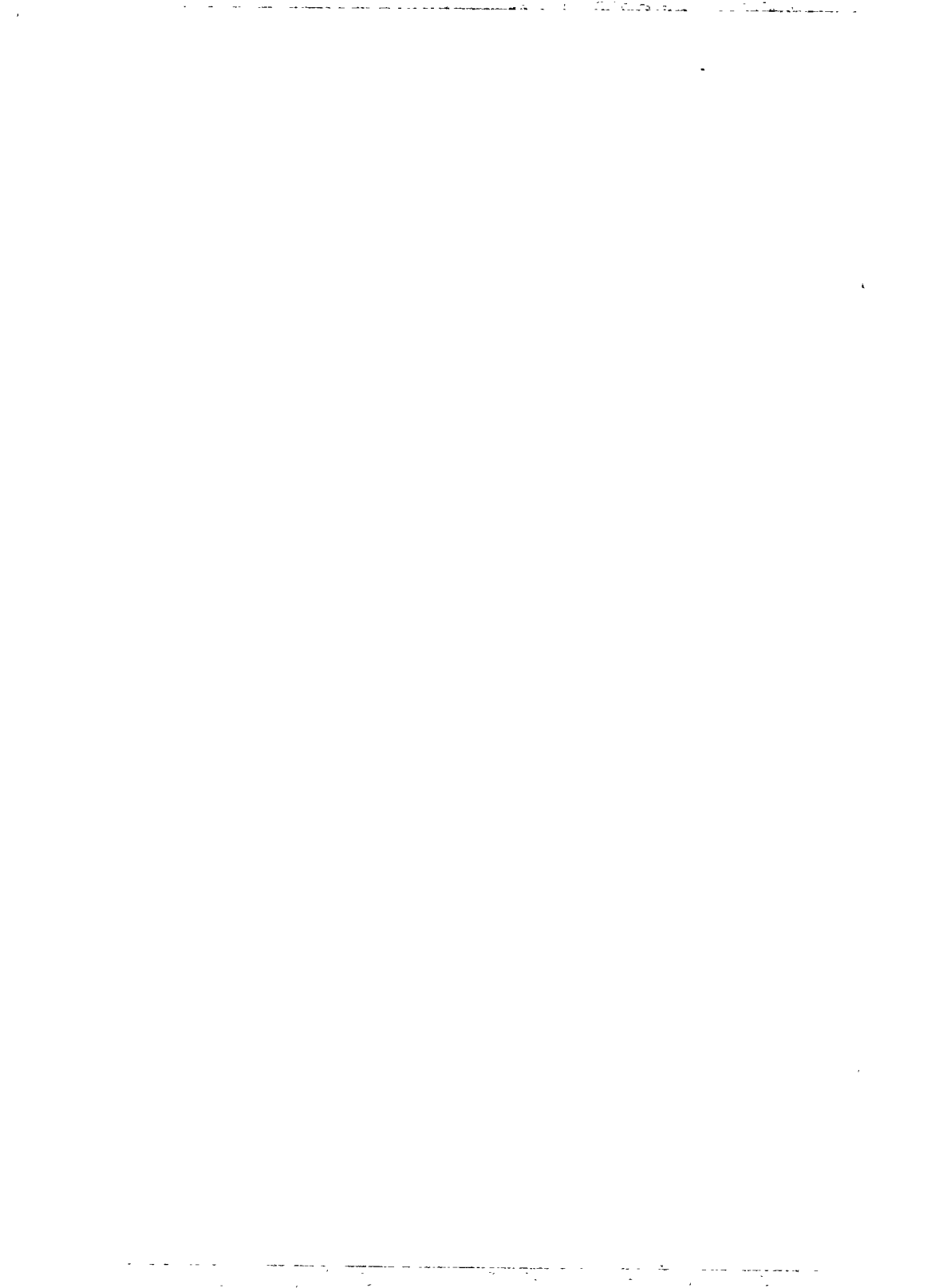

**AZ 8140**

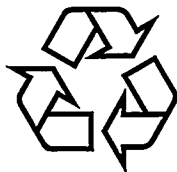

**Philips Consumer Electronics Company**  
A Division of Philips Electronics North America Corporation

3139 116 14593

Printed In Hong Kong